

# G2 CCD Camera User's Guide



moravian instruments

Manual version 3.3, modified on September 25<sup>th</sup>, 2017

All information furnished by Moravian Instruments is believed to be accurate. Moravian Instruments reserves the right to change any information contained herein without notice.

G2 cameras are not authorized for and should not be used within Life Support Systems without the specific written consent of the Moravian Instruments. Product warranty is limited to repair or replacement of defective components and does not cover injury or property or other consequential damages.

Copyright © 2000-2017, Moravian Instruments

Moravian Instruments

Masarykova 1148

763 02 Zlín

Czech Republic

tel./fax: +420 577 107 171

www: <http://www.gxccd.com/>

e-mail: [info@gxccd.com](mailto:info@gxccd.com)

# Table of Contents

Introduction.....	4
G2 Camera Overview.....	6
CCD and Camera Electronics.....	9
CCD Chip.....	12
Model G2-0402.....	13
Model G2-1600.....	13
Model G2-3200.....	14
Model G2-8300.....	14
Model G2-2000.....	14
Model G2-4000.....	15
Camera Electronics.....	15
Model G2-0402.....	16
Model G2-1600.....	16
Model G2-3200.....	17
Model G2-8300.....	17
Model G2-2000.....	17
Model G2-4000.....	17
CCD Cooling and Power Supply.....	18
Power Supply.....	18
Mechanical Specifications.....	21
Camera with Internal Filter Wheel.....	22
Camera with “XS” External Filter Wheel.....	24
Telescope adapters.....	26
Off-Axis Guider Adapter (OAG).....	27
Attaching camera head to telescope mount.....	28
Camera head color variants.....	29
Camera Maintenance.....	30
Desiccant exchange.....	30
Changing the silica-gel.....	31
Changing Filters.....	33
Opening the camera head.....	33
Changing the Whole Filter Wheel.....	34
Changing the Telescope Adapter.....	35
Power Supply Fuse.....	35
G2 Camera Revisions.....	36
Revision 1.....	36
Revision 2.....	36
Revision 3.....	37
Revision 4.....	38

---

# Introduction

Thank you for choosing the G2 camera. The cooled, slow-scan series of G2 cameras were developed for imaging under extremely low-light conditions in astronomy, microscopy and similar areas. The development team focused to every detail of camera mechanics, cooling, electronics and software to create state-of-the-art product. G2 cameras feature compact and robust construction, rich features, sophisticated software support and easy operation.

G2 cameras can contain internal filter wheels with 5 or 6 positions. Camera variants without internal filter wheel can control external filter wheels with number of filter positions varying from 7 to 12, depending on the external filter wheel type and filter dimension.

Please note the G2 cameras are designed to work in cooperation with a host Personal Computer (PC). As opposite to digital still cameras, which are operated independently on the computer, the scientific slow-scan, cooled cameras usually require computer for operation control, image download, processing and storage etc. To operate the G2 camera, you need a computer which:

1. Is compatible with a PC standard.
2. Runs a modern 32-bit or 64-bit Windows operating system.

Drivers for 32-bit and 64-bit Linux systems are also provided, but camera control and image processing software, supplied with the camera, requires Windows operating system.

3. Provides at last one free USB port.

The current series of G2 CCD cameras are designed to operate with USB 2.0 high-speed (480 Mbps) hosts. Although they are fully backward compatible with USB 1.1 full-speed (12 Mbps) hosts, image download time can be somewhat longer if USB 1.1 connection is used.

A simple and cheap device called USB hub can expand number of available USB port. Typical USB hub occupies one computer USB port and offers four free ports. Make sure the USB hub is USB 2.0

high-speed compatible.

But keep on mind that if more USB devices connected to one hub need to communicate with a host PC, USB hub shares its single up link line to the host PC. Although G2 CCD cameras can operate through a USB hub, it can negatively affect the camera performance, like download time etc. It is recommended to connect other USB devices through USB hub (e.g. the mouse) and to provide the camera a direct USB connection to the host PC.

4. Alternatively it is possible to use the Gx Camera Ethernet Adapter. This device can connect up to four Gx cameras of any type (not only G2, but also large format G3 and G4 as well as G0 and G1 pointers) and offers 1 Gbps and 10/100 Mbps Ethernet interface for direct connection to the host PC. Because the PC then uses TCP/IP protocol to communicate with the cameras, it is possible to insert e.g. WiFi bridge or other networking device to the communication path.

The G2 cameras need an external power supply to operate. It is not possible to run the camera from the power lines provided by the USB cable, which is common for webcams or very simple imagers. G2 cameras integrate highly efficient CCD chip cooling, shutter and filter wheel, so their power requirements significantly exceed USB line power capabilities. On the other side separate power source eliminates problems with voltage drop on long USB cables or with drawing of laptop batteries etc.

Also note the camera must be connected to some optical system (e.g. the telescope) to capture images. The camera is designed for long exposures, necessary to acquire the light from faint objects. If you plan to use the camera with the telescope, make sure the whole telescope/mount setup is capable to track the target object smoothly during the exposure.

---

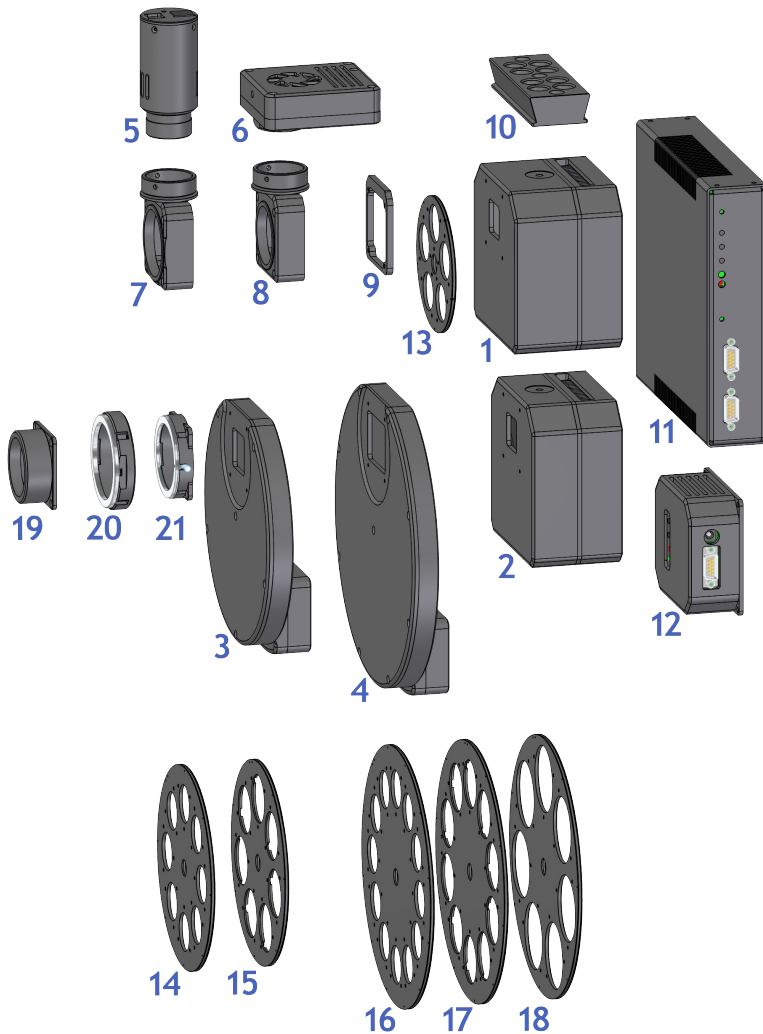
# G2 Camera Overview

G2 camera head is designed to be easily used with a set of accessories to fulfill various observing needs. Camera head itself is manufactured in two different variants:

- Camera with internal filter wheel.
- Camera with control port for external filter wheel. This model allows attachment of several variants of external filter wheels with various number of filter positions and sizes.



*Illustration 1: G2 camera without filter wheel (left), with internal filter wheel (middle) and with attached external filter wheel (right).*



*Illustration 2: Schematic diagram of G2 camera system components*

Components of G2 Camera system include:

1. G2 camera head with Internal Filter Wheel (5 or 6 positions)
2. G2 camera head capable to control External Filter Wheel
3. External Filter Wheel “XS” size (7 or 8 positions)
4. External Filter Wheel “S” size (10 or 12 positions)
5. G0 guider camera
6. G1 guider camera
7. Off-Axis Guider with M48×0.75 thread
8. Off-Axis Guider with M42×0.75 thread (T2)
9. Spacer compensating IFW and EFW back focal distance
10. 1.75” dovetail rail for G2 camera head
11. Gx Camera Ethernet Adapter (x86 CPU)
12. Gx Camera Ethernet Adapter (ARM CPU)

Camera Ethernet Adapter allows connection of up to 4 Gx cameras of any type on the one side and 1 Gbps Ethernet on the other side. This adapter allows access to connected Gx cameras using routable TCP/IP protocol over practically unlimited distance.

13. 5-positions internal filter wheel for 1.25”/D31 mm filters
14. 8-positions external filter wheel “XS” for 1.25”/D31 mm filters
15. 7-positions external filter wheel “XS” for D36 mm filters
16. 12-positions external filter wheel “S” for 1.25”/D31 mm filters
17. 10-positions external filter wheel “S” for D36 mm filters
18. 7-positions external filter wheel “S” for 2”/D50 mm filters
19. M42×0.75 (T-thread) or M48×0.75 threaded adapters, 55 mm BFD
20. Canon EOS lens adapter
21. Nikon lens adapter



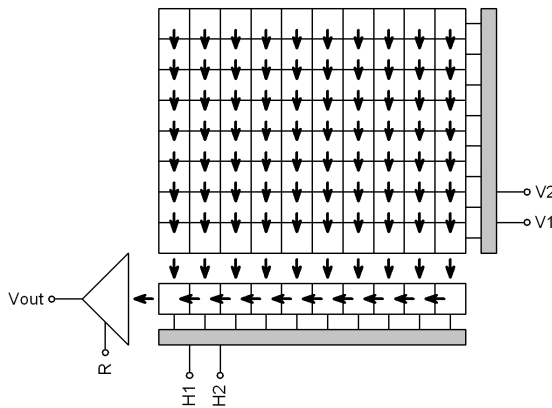
---

# CCD and Camera Electronics

G2 series of CCD cameras are manufactured with two kinds of CCD detectors:

- **G2 cameras with OnSemi KAF Full Frame (FF) CCD architecture.** Almost all Full Frame CCD detector area is exposed to light. This is why these detectors provide very high quantum efficiency. FF CCD detectors, intended for research applications, are not equipped with so-called Anti Blooming Gate (ABG – a gate, which prohibits blooming of the charge to neighboring pixels when image is over-exposed) to ensure linear response to light through the whole dynamic range. FF CCD detectors used for astrophotography are equipped with ABG to eliminate disrupting blooming streaks within field of view.

Cameras with Full Frame, non-ABG detectors are suitable for scientific applications, where linear response is necessary for photometric applications in astronomy, microscopy etc. High quantum efficiency could be used also for narrow-band imaging, where overexposure is a rare exception, and for imaging of small objects without a bright star in the field of view.



*Illustration 3: "Full Frame" CCD schematic diagram*

- **G2 cameras with OnSemi KAI Interline Transfer (IT) architecture.** There is a shielded column of pixels just beside each column of active pixels on these detectors. The shielded columns are called Vertical registers. One pulse moves charge from exposed pixels to shielded pixels on the end of each exposure. The the charge is moved from vertical registers to horizontal register and digitized in the same way like in the case of Full Frame detectors. This mechanism is also known as “electronic shutter”, because it allows very short exposures and also digitization of the image without mechanically shielding of the detector from incoming light.

Also G2 cameras with IT CCDs are equipped with mechanical shutter, because electronic shutter does not allow dark-frame exposures, necessary for proper image calibration etc.

The price for electronic shutter is lower quantum efficiency (sensitivity) of IT detectors compared to FF ones. Also all IT detectors are equipped with ABG, so they can acquire images of very bright objects without charge blooming to neighboring pixels.

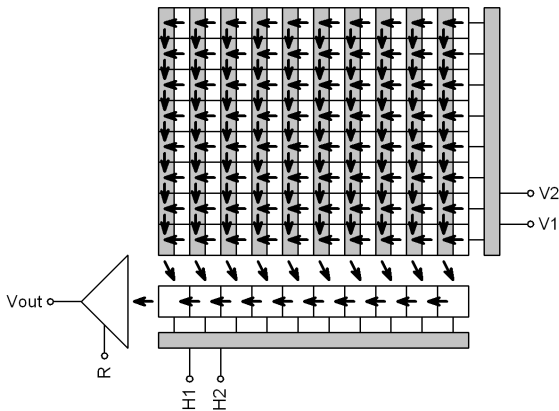
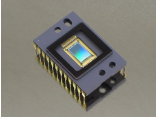
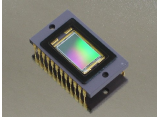
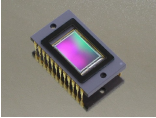
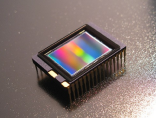


Illustration 4: “Interline Transfer” CCD schematic diagram

G2 camera models with Full Frame CCD detectors:

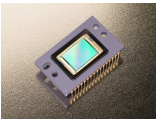
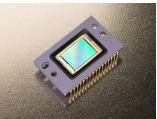
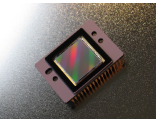
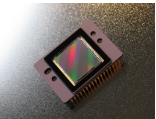
Model	G2-0402	G2-1600	G2-3200	G2-8300
CCD chip	KAF-0402ME	KAF-1603ME	KAF-3200ME	KAF-8300
Resolution	768×512	1536×1024	2184×1472	3358×2536
Pixel size	9×9 μm	9×9 μm	6.8×6.8 μm	5,4×5,4 μm
CCD area	6.9×4.6 mm	13.8×9.2 mm	14.9×10.0 mm	18,1×13,7 mm
ABG	No	No	No	Yes
Color mask	No	No	No	No (see Note)

G2-8300 camera is available in the G2-8300C version with color CCD detector (with Bayer mask), capable of single-shot color images.

G2 camera models with Interline Transfer CCD detectors::

Model	G2-2000	G2-2000C	G2-4000	G2-4000C
CCD chip	KAI-2020	KAI-2020	KAI-4022	KAI-4022
Resolution	1604×1204	1604×1204	2056×2062	2056×2062
Pixel size	7,4×7,4 μm	7,4×7,4 μm	7,4×7,4 μm	7,4×7,4 μm
CCD area	11,8×9,0 mm	11,8×9,0 mm	15,2×15,2 mm	15,2×15,2 mm
ABG	Yes	Yes	Yes	Yes
Color mask	No	Yes	No	Yes

Cameras with “C” suffix contains CCD detector covered with so-called Bayer mask. Color filters of three basic colors (red, green, blue) cover all pixels, so

every pixels detects only light of particular color.

These cameras are able to acquire color image in single exposure, without the necessity to change color filters. On the other side color mask brings lower sensitivity and limits the capability to perform exposures using narrow-band filters etc.

Because each pixel is covered by one of three basic color filters, it is necessary to compute (interpolate) remaining two colors for each pixel, which of course limits resolution of color image. Imaging using color detectors is described in the “Color images” chapter.

## CCD Chip

Quantum efficiency (sensitivity) of CCD detectors used in G2 cameras depends on the particular camera model.

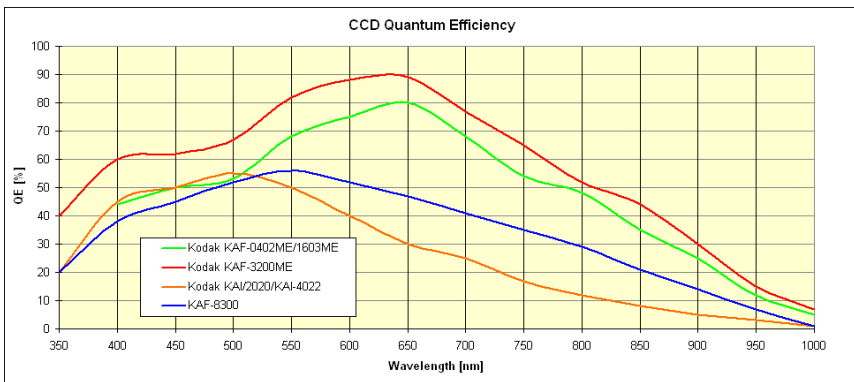


Illustration 5: Quantum efficiency of OnSemi CCD detectors used in G2 cameras

Inherent dark current of these detectors is quite low compared to other CCD detectors, suitable for scientific applications, which results into very good signal/noise ratio.

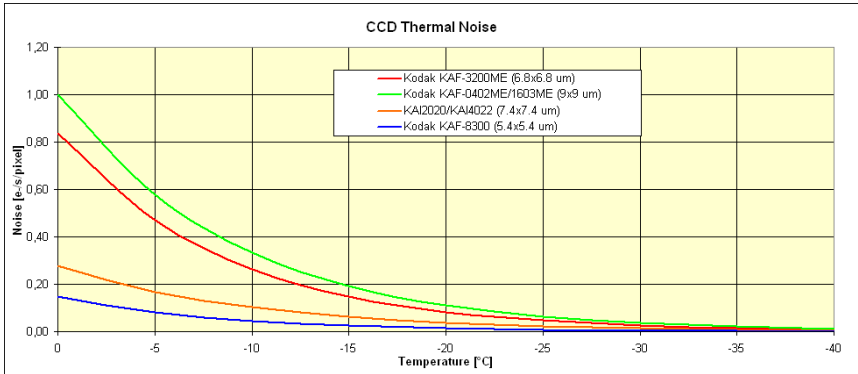


Illustration 6: Dark current of some OnSemi CCD detectors, used in G2 cameras

## Model G2-0402

G2-0402 model uses 0.4 MPx OnSemi KAF-0402ME.

<b>Resolution</b>	768×512 pixels
<b>Pixel size</b>	9×9 μm
<b>Imaging area</b>	6.9×4.6 mm
<b>Full well capacity</b>	Approx. 100 000 e <sup>-</sup>
<b>Output node capacity</b>	Approx. 220 000 e <sup>-</sup>
<b>Dark current</b>	1 e <sup>-</sup> /s/pixel at 0°C
<b>Dark signal doubling</b>	6.3 °C

## Model G2-1600

G2-1600 model uses 1.6 MPx OnSemi KAF-1603ME.

<b>Resolution</b>	1536×1024 pixels
<b>Pixel size</b>	9×9 μm
<b>Imaging area</b>	13.8×9.2 mm
<b>Full well capacity</b>	Approx. 100 000 e <sup>-</sup>
<b>Output node capacity</b>	Approx. 220 000 e <sup>-</sup>

<b>Dark current</b>	1 e <sup>-</sup> /s/pixel at 0°C
<b>Dark signal doubling</b>	6.3 °C

### Model G2-3200

G2-3200 model uses 3.2 MPx OnSemi KAF-3200ME.

<b>Resolution</b>	2184×1472 pixels
<b>Pixel size</b>	6.8×6.8 μm
<b>Imaging area</b>	14.9×10.0 mm
<b>Full well capacity</b>	Approx. 55 000 e <sup>-</sup>
<b>Output node capacity</b>	Approx. 110 000 e <sup>-</sup>
<b>Dark current</b>	0.8 e <sup>-</sup> /s/pixel at 0°C
<b>Dark signal doubling</b>	6 °C

### Model G2-8300

G2-8300 model uses 8 MPx OnSemi KAF-8300.

<b>Resolution</b>	3358×2536 pixels
<b>Pixel size</b>	5,4×5,4 μm
<b>Imaging area</b>	18,1×13,7 mm
<b>Full well capacity</b>	Approx. 25 000 e <sup>-</sup>
<b>Output node capacity</b>	Approx. 55 000 e <sup>-</sup>
<b>Dark current</b>	0.15 e <sup>-</sup> /s/pixel at 0°C
<b>Dark signal doubling</b>	5.8 °C

KAF-8300 CCD detector with color (Bayer) mask can be used in the G2-8300C camera.

### Model G2-2000

G2-2000 uses 2 MPx CCD OnSemi KAI-2020.

<b>Resolution</b>	1604×1204 pixels
<b>Pixel size</b>	7.4×7.4 μm
<b>Imaging area</b>	11.9×8.9 mm

<b>Full well capacity</b>	Approx. 40 000 e <sup>-</sup>
<b>Output node capacity</b>	Approx. 80 000 e <sup>-</sup>
<b>Dark current</b>	0.3 e <sup>-</sup> /s/pixel at 0°C
<b>Dark signal doubling</b>	7 °C

KAI-2020 CCD detector with color (Bayer) mask can be used in the G2-2000C camera.

## Model G2-4000

G2-2000 uses 4 MPx CCD OnSemi KAI-4022.

<b>Resolution</b>	2056×2062 pixels
<b>Pixel size</b>	7.4×7.4 μm
<b>Imaging area</b>	15.2×15.2 mm
<b>Full well capacity</b>	Approx. 40 000 e <sup>-</sup>
<b>Output node capacity</b>	Approx. 80 000 e <sup>-</sup>
<b>Dark current</b>	0.3 e <sup>-</sup> /s/pixel at 0°C
<b>Dark signal doubling</b>	7 °C

KAI-4022 CCD detector with color (Bayer) mask can be used in the G2-4000C camera.

## Camera Electronics

16-bit A/D converter with correlated double sampling ensures high dynamic range and CCD chip-limited readout noise. Fast USB interface ensures image download time within seconds.

### Remark

Stated values are valid for G2 cameras revision 4. Previous revisions could differ in some parameters. Refer to chapter “G2 Camera Revisions” for differences among individual revisions.

Some parameters (e.g. camera gain) are defined by the used system driver, so they depend on the version of actually used driver. If the Gx Camera Ethernet Adapter is used, system driver is defined by the firmware version of the Ethernet Adapter device.

<b>ADC resolution</b>	16 bits
<b>Sampling method</b>	Correlated double sampling
<b>Read modes</b>	Preview
	Low-noise
<b>Horizontal binning</b>	1 to 4 pixels
<b>Vertical binning</b>	1 to 4 pixels
<b>Sub-frame readout</b>	Arbitrary sub-frame
<b>Computer interface</b>	USB 2.0 high-speed
	USB 1.1 full-speed compatible

Binning can be combined independently on both axes.

Image download time and system read noise depends on the CCD chip used in particular camera model.

### Model G2-0402

<b>Gain</b>	1.5e <sup>-</sup> /ADU (1×1 binning)
	2.0e <sup>-</sup> /ADU (other binnings)
<b>System read noise</b>	14 e <sup>-</sup> (Low Noise mode)
	16 e <sup>-</sup> (Preview mode)
<b>Full frame download</b>	0.7 s (Low Noise mode)
	0.5 s (Preview mode)

### Model G2-1600

<b>Gain</b>	1.5e <sup>-</sup> /ADU (1×1 binning)
	2.0e <sup>-</sup> /ADU (other binnings)
<b>System read noise</b>	14 e <sup>-</sup> (Low Noise mode)
	16 e <sup>-</sup> (Preview mode)
<b>Full frame download</b>	2.6 s (Low Noise mode)
	1.8 s (Preview mode)



## Model G2-3200

<b>Gain</b>	0.8 e <sup>-</sup> /ADU (1×1 binning)
	1.3 e <sup>-</sup> /ADU (other binnings)
<b>System read noise</b>	7 e <sup>-</sup> (Low Noise mode)
	10 e <sup>-</sup> (Preview mode)
<b>Full frame download</b>	5.5 s (Low Noise mode)
	3.8 s (Preview mode)

## Model G2-8300

<b>Gain</b>	0.4 e <sup>-</sup> /ADU (1×1 binning)
	0.8 e <sup>-</sup> /ADU (other binnings)
<b>System read noise</b>	8 e <sup>-</sup> (Low Noise mode)
	9 e <sup>-</sup> (Preview mode)
<b>Full frame download</b>	14.2 s (Low Noise mode)
	9.8 s (Preview mode)

## Model G2-2000

<b>Gain</b>	0.5 e <sup>-</sup> /ADU (1×1 binning)
	0.8 e <sup>-</sup> /ADU (other binnings)
<b>System read noise</b>	7 e <sup>-</sup> (Low Noise mode)
	9 e <sup>-</sup> (Preview mode)
<b>Full frame download</b>	3.1 s (Low Noise mode)
	2.1 s (Preview mode)

## Model G2-4000

<b>Gain</b>	0.5 e <sup>-</sup> /ADU (1×1 binning)
	0.8 e <sup>-</sup> /ADU (other binnings)
<b>System read noise</b>	7 e <sup>-</sup> (Low Noise mode)
	9 e <sup>-</sup> (Preview mode)
<b>Full frame download</b>	6.7 s (Low Noise mode)
	4.5 s (Preview mode)

---

# CCD Cooling and Power Supply

Regulated two-stage thermoelectric cooling is capable to cool the CCD chip up to 50 °C below ambient temperature. The Peltier hot side is cooled by a fan. The CCD chip temperature is regulated with  $\pm 0.1$  °C precision. High temperature drop and precision regulation ensure very low dark current for long exposures and allow image proper calibration.

The camera head contains two temperature sensors – the first sensor measures directly the temperature of the CCD chip. The second one measures the temperature of the air cooling the Peltier hot side.

The cooling performance depends on the environmental conditions and also on the power supply. If the power supply voltage drops below 12 V, the maximum temperature drop is lower.

<b>CCD chip cooling</b>	Thermoelectric (Peltier modules)
<b>Maximal <math>\Delta T</math></b>	>50 °C below ambient
<b>Regulated <math>\Delta T</math></b>	48 °C below ambient (85% cooling)
<b>Regulation precision</b>	$\pm 0.1$ °C
<b>Hot side cooling</b>	Forced air cooling (fan)

Maximum temperature difference between CCD and ambient air may exceed 50 °C when the cooling runs at 100% power. However, temperature cannot be regulated in such case, camera has no room for lowering the CCD temperature when the ambient temperature rises. The 45 °C temperature drop can be achieved with cooling running at approx. 85% power, which provides enough room for regulation.

## Power Supply

The 12 V DC power supply enables camera operation from arbitrary power source including batteries, wall adapters etc. Universal 100-240 V AC/50-60 Hz, 60 W “brick” adapter is supplied with the camera. Although the camera

power consumption does not exceed 30 W, the 60 W power supply ensures noise-free operation.

<b>Camera head supply</b>	12 V DC
<b>Camera head power consumption</b>	15 W without cooling 40 W 100% cooling
<b>Power connector</b>	5.5/2.5 mm, center +
<b>Adapter input voltage</b>	100-240 V AC/50-60 Hz
<b>Adapter output voltage</b>	12 V DC/5 A
<b>Adapter maximum power</b>	60 W

Power consumption is measured on the AC side of the supplied 12 V AC/DC power supply. Camera consumes less energy from 12 V power supply than state here.

The camera contains its own power supplies inside, so it can be powered by unregulated 12 V DC power source – the input voltage can be anywhere between 10 and 14 V. However, some parameters (like cooling efficiency) can degrade if the supply drops below 12 V.

G2 camera measures its input voltage and provides it to the control software. Input voltage is displayed in the “Cooling” tab of the “Imaging Camera” control tool in the SIPS. This feature is important especially if you power the camera from batteries.



*Illustration 7: 12 V DC/5 A power supply adapter for G2 CCD Camera*

**Warning:**

The power connector on the camera head uses center-plus pin. Although all modern power supplies use this configuration, always make sure the polarity is correct if you use own power source.

---

# Mechanical Specifications

Compact and robust camera head measures only 114×114×65 mm (approx. 4.5×4.5×2.6 inches). The head is CNC-machined from high-quality aluminum and black anodized. The head itself contains USB-B (device) connector and 12 V DC power plug. Integrated mechanical shutter allows streak-free image readout, as well as automatic dark frame exposures, which are necessary for unattended, robotic setups. Integrated filter wheel contains 5 positions for standard 1.25-inch threaded filter cells. A variant of filter wheel with 6 positions for the same filters without cells (only a glass) is also available.

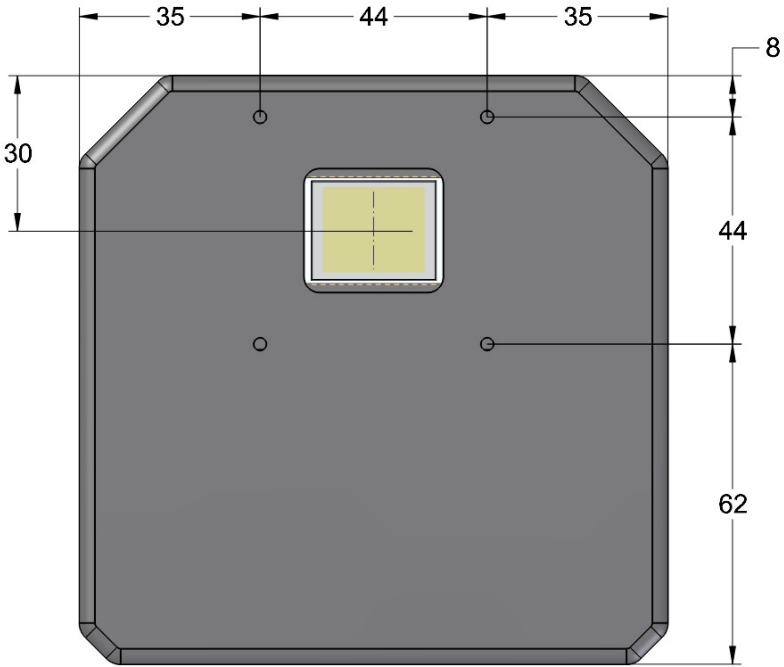
---

<b>Internal mechanical shutter</b>	Yes, blade shutter
<b>Shortest exposure time</b>	0.1 s
<b>Longest exposure time</b>	Limited by chip saturation only
<b>Internal filter wheel</b>	5 positions for 1.25" threaded filter cells or for 31 mm glass-only filters
	6 positions for 26 mm glass-only filters
<b>Head dimensions</b>	114×114×77.5 mm (with internal filter wheel)
	114×114×65 mm (without filter wheel)
<b>Back focal distance</b>	29 mm (with internal filter wheel)
	16.5 mm (without filter wheel)
	33.5 mm (with external filter wheel)
<b>Camera head weight</b>	1.15 kg (with internal filter wheel)
	1.00 kg (without filter wheel)
	1.70 kg (with "XS" external filter wheel)
	1.95 kg (with "S" external filter wheel)

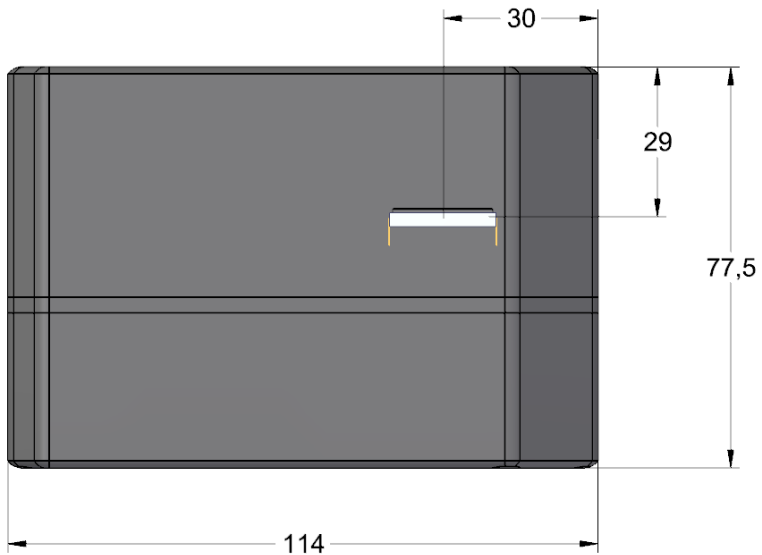
---

Filter wheel with 6 positions can cause vignetting (shielding of the detector corners) if large CCD detector is used.

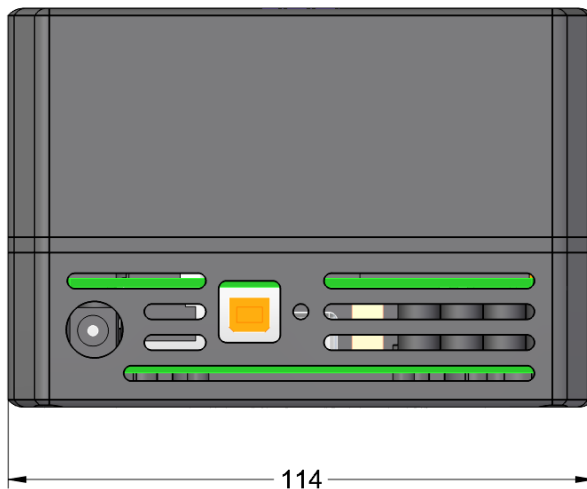
## Camera with Internal Filter Wheel



*Illustration 8: G2 camera head front view dimensions*

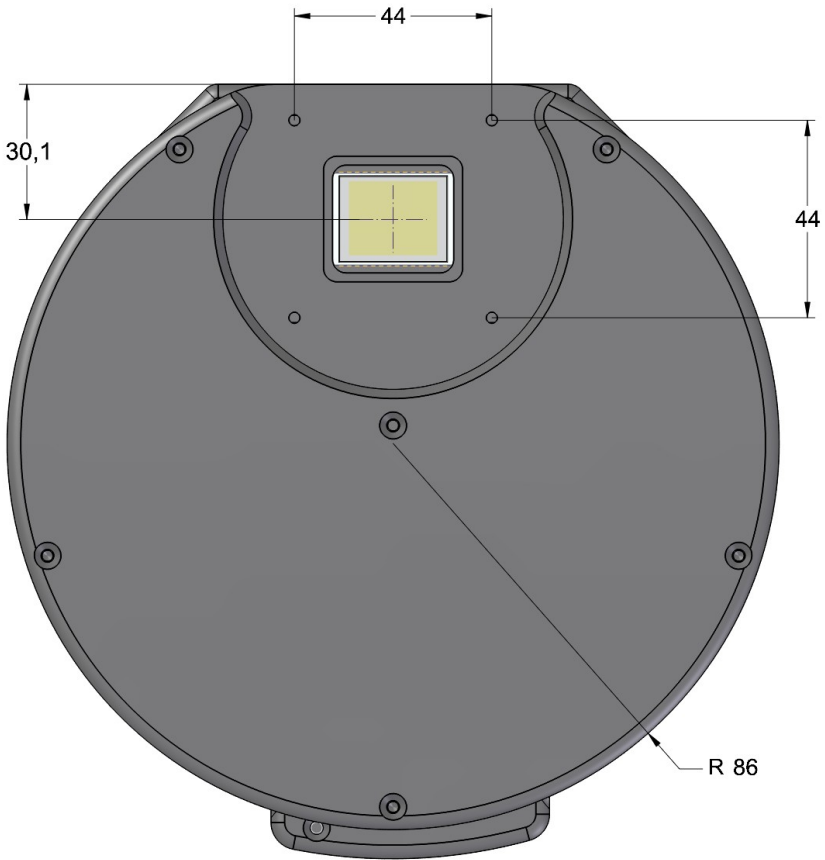


*Illustration 9: G2 camera head with Internal Filter Wheel side view dimensions*



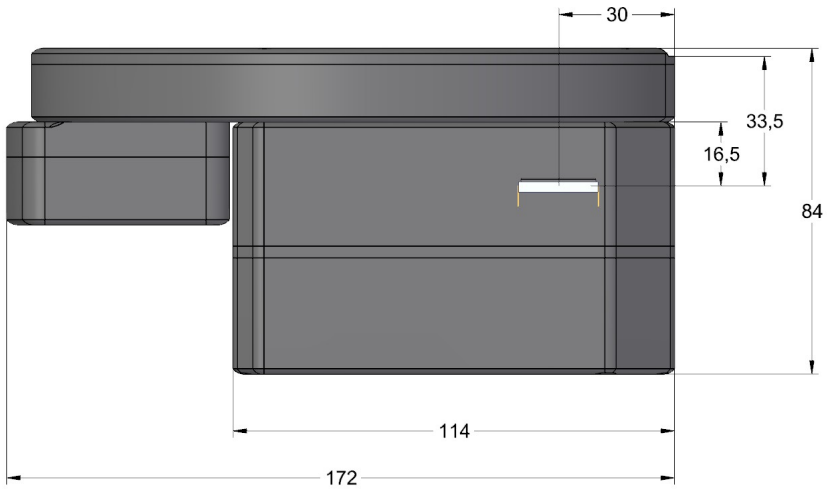
*Illustration 10: G2 camera head bottom view dimensions*

## Camera with “XS” External Filter Wheel

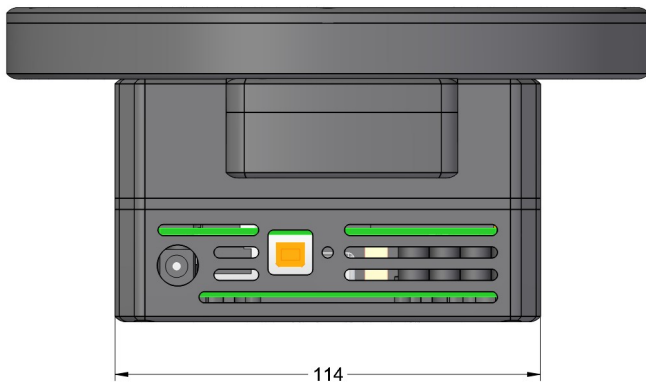


*Illustration 11: G2 camera head with External Filter Wheel front view dimensions*





*Illustration 12: G2 camera head with external filter wheel side view dimensions*



*Illustration 13: G2 camera head with external filter wheel bottom view dimensions*

The “S” sized External Filter Wheel diameter is greater (see External Filter Wheel User's Guide), but the back focal distance of all external filter wheels is identical.

## Telescope adapters

Various telescope and lens adapters for the G2 cameras are offered. Users can choose any adapter according to their needs and another adapters can be ordered separately.

It is possible to choose among various telescope/lens adapters:

---

**2" barrel adapter**



Adapter for 2" focusers.

---

**T-thread short**



M42×0.75 mm inner thread,  
7.5 mm thick.

---

**T-thread with  
55 mm BFD**



M42×0.75 mm inner thread,  
preserves 55 mm back focal  
distance.

---

**M48×0.75 thread  
short**



Adapter with inner thread  
M48×0.75, 7.5mm thick

---

**M48×0.75 thread  
with 55 mm BFD**



Adapter with inner thread  
M48×0.75, preserves 55 mm  
back focal distance.





---

**Pentax (Praktica)  
lens adapter**



M42×1 mm inner thread,  
preserves 45.5 mm back  
focal distance.

---

<b>M68×1 thread adapter</b>		Adapter with inner thread M68×1
<b>Canon EOS lens adapter</b>		Standard Canon EOS bayonet adapter.
<b>Canon EOS clip lens adapter</b>		Canon EOS bayonet adapter with the possibility to insert “clip” filter. Can be used on cameras with internal filter wheel only.
<b>Nikon F lens adapter</b>		Standard Nikon F bayonet adapter.

If the mounting standard defines also back focal distance (distance from adapter front plane to detector), the particular adapter is constructed to preserve defined distance (for instance T-thread defines back focal distance to 55 mm, but certain distance is defined also for Pentax (Praktica) thread, for Canon EOS and Nikon bayonets etc.).

Adapters are attached to the camera body using four M3 (3 mm metric) screws, placed on the corners of 44 mm square. Custom adapters can be made upon request.

## Off-Axis Guider Adapter (OAG)

G2 camera can be optionally equipped with Off-Axis Guider Adapter. This adapter contains flat mirror, tilted by 45° to the optical axis. This mirror reflects part of the incoming light into guider camera port. The mirror is located far enough from the optical axis not to block light coming to the main camera sensor, so the optics must be capable to create large enough field of view to

illuminate the tilted mirror.

G2-OAG is manufactured in two variants, one with M42×0.75 thread (T-thread) and another with M48×0.75 thread. Both variants are designed to be compatible with external filter wheels and to preserve 55 mm distance from the sensor.

If the OAG has to be used on camera with internal filter wheel, it is necessary to insert a spacer between OAG and camera head compensating BFD difference. Similar, but thicker spacer must be used when OAG is mounted to camera without filter wheel at all.

OAG guider port is compatible with G0 and G1 cameras. It is necessary to replace the CS/1.25" adapter with short, 10 mm variant in the case of G1 cameras. Because G1 cameras follow CS-mount standard, (BFD 12.5 mm), any camera following this standard with 10 mm long 1.25" adapter should work properly with the G2-OAG.



*Illustration 14: G2-OAG with M42 (left) and M48 thread (right)*

## **Attaching camera head to telescope mount**

G2 camera heads are equipped with “tripod” thread (0.25”) on the top side.

This thread can be used to attach 1.75 inch “dovetail bar” (Vixen standard). It is then possible to attach the camera head, e.g. equipped with photographic lens, directly to various telescope mounts supporting this standard.



*Obr. 15: 1.75" bar for standard telescope mounts*

## **Camera head color variants**

Camera head is available in several color variants of the center plate. Visit manufacturer's web pages for current offering.



*Illustration 16: G2 camera color variants*

---

# Camera Maintenance

The G2 CCD camera is a precision optical and mechanical instrument, so it should be handled with care. Camera should be protected from moisture and dust. Always cover the telescope adapter when the camera is removed from the telescope or put the whole camera into protective plastic bag.

## Desiccant exchange

The G2 CCD cooling is designed to be resistant to humidity inside the CCD chamber. When the temperature decreases, the copper cold finger crosses freezing point earlier than the CCD chip itself, so the water vapor inside the CCD chamber freezes on the cold finger surface first. Although this mechanism works very reliably in majority of cases, it has some limitations, especially when the humidity level inside the CCD chamber is high or the chip is cooled to very low temperatures.

This is why a cylindrical container, filled with silica-gel desiccant, is placed inside the camera head. This cylindrical chamber is connected with the insulated cooled CCD chamber itself.

### Warning:

High level of moisture inside the CCD cold chamber can cause camera malfunction or even damage to the CCD sensor. Even if the frost does not create on the detector when the CCD is cooled below freezing point, the moisture can be still present. It is necessary to keep the CCD chamber interior dry by the regular exchange of the silica-gel desiccant. The frequency of necessary silica-gel exchanges depends on the camera usage. If the camera is used regularly, it is necessary to dry the CCD chamber every few months.

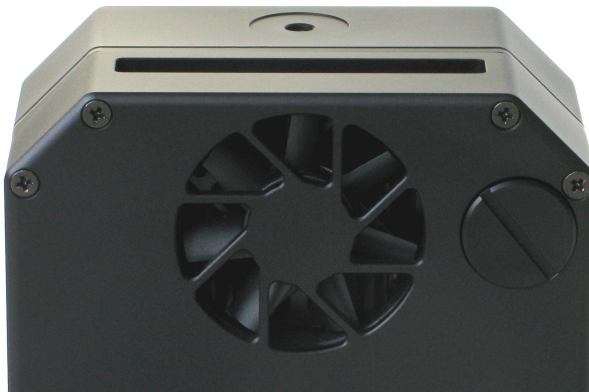
It is possible dry the wet silica-gel by baking it in the oven (not the microwave one!) to dry it again. Dry the silica-gel for at last one or two hours at temperature between 120 and 140 °C.

The silica-gel used in G2 cameras changes its color according to amount of water absorbed – it is bright yellow or orange when it is dry and turns to

transparent without any color hue when it becomes wet. It is recommended to shorten replacement interval if the silica-gel is completely transparent upon replacement. If it is still yellow-orange, it is possible to prolong the replacement interval.

**Note:**

The silica-gel ability to absorb moisture depends on the ambient temperature. If the camera is located in the environment with below freezing point temperatures, drying of the CCD cold chamber can take up to several days.



*Illustration 17: Silica-gel container is accessible from the camera back side*

## **Changing the silica-gel**

The desiccant container design depends on the camera revision:

- G2 cameras revisions 1 and 2 employed desiccant container accessible only from inside of the camera. It was necessary to open the camera head before the desiccant could be replaced.
- G2 cameras revision 3 have the container accessible from the back side of the camera head. The slotted desiccant chamber cap can be unscrewed e.g. by a coin. Pour out wet silica-gel and fill the chamber with a dry one. The desiccant chamber can be filled with a hot silica-gel without a danger of damaging of the container.

The desiccant container can be left open without the fear from contamination of CCD chamber interior by dust. There is a very faint stainless steel grid between the CCD chamber and the desiccant container, so dust particles cannot enter the chamber itself. It is even recommended to keep the desiccant container cap off for a couple of hours when the camera is in the room with low humidity. This helps drying the CCD chamber interior and prolongs the silica-gel exchange interval.

- G2 revision 4 cameras brought larger desiccant container (equal to the one used in larger G3 and G4 cameras).

Cameras supplied in 2016 and later are equipped with a redesigned desiccant containers. New containers are no longer a fixed part of the camera body with only a removable cap, but the whole container can be unscrewed. The main advantage of this design is the ability to exchange silica-gel without the necessity to remove the camera from the telescope, which was necessary to be able to pour-out the silica-gel and then to pour it in.

Silica-gel is held inside the container with a perforated cap. This cap is also screwed into the container body, so it is easy to exchange the silica-gel inside the container after it is worn out or damaged e.g. by too high temperature etc.

The container itself does not contain any sealing (the sealing remains attached to the CCD cold chamber inside the camera head), it consists of aluminum parts only. So it is possible to heat the whole container to desired temperature without risking of the temperature-induced sealing damage.

This design also allows usage of some optional parts. First it is a threaded hermetic cap, which allows sealing of the dried container when it is not immediately attached to the camera head. And the second one is an alternate (somewhat longer) desiccant container, modified to be able to be screw in and tightened (as well as released and screwed out) without any tool.

The sealed cap as well as the tool-less container are not supplied with the camera, they are supplied only as optional accessory.





*Illustration 18: Optional cap, standard container and the tool-less variant of the container*

## Changing Filters

It is necessary to open the camera head to change filters or the whole filter wheel. To open the head unscrew the six bolts holding camera head together.

### Opening the camera head

The blade shutter rotates 180° between individual snapshots. Camera cover could be opened only when the shutter fully closed (covers the CCD). If for instance the camera is unplugged from power adapter while exposing, the shutter remains open. Camera cannot be opened in such case.

#### Warning:

Shutter can be damaged while removing the camera cover if not in proper position.

After removing the screws carefully turn the camera head by the telescope adapter upward. Gently pull the front part of the case. Notice there are two cables, connecting the filter wheel motor and the filter position optical bar, plugged into the electronics board. It is not necessary to unplug these cables to change filters, but if you unplug them, take care to connect them again in the

proper orientation!



*Illustration 19: Filter positions are marked on the filter wheel*



*Illustration 20: Filters can be exchanged after removing of the camera front cover*

## **Changing the Whole Filter Wheel**

The whole filter wheel can be changed at once. It is necessary to remove the front part of the camera case the same way as in the case of changing filters.

The filter wheel can be removed when you unscrew the bolt on the center of the front part of camera case. Take care not to damage the horseshoe-shaped optical bar when replacing the filter wheel.

## **Changing the Telescope Adapter**

The camera head contains bolt square. The telescope adapter is attached by four bolts. If you want to change the adapter, simply unscrew these bolts and replace the adapter with the new one.

## **Power Supply Fuse**

The power supply inside the camera is protected against connecting of inverted-polarity power plug or against connecting of too-high DC voltage (above 15 V) by a fuse. If such event happens and the cooling fans on the back side of the camera do not work when the camera is connected to proper power supply, return the camera to the service center for repair.

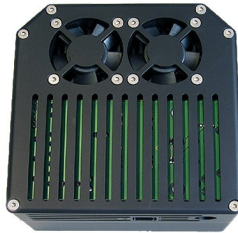
---

# G2 Camera Revisions

G2 series of CCD cameras underwent several revisions, each implementing various enhancements, new printed circuits boards with latest electronics components and utilizing all gained experience and new ideas.

## Revision 1

The first introduced G2 camera. Only G2-0400 model with KAF0402ME CCD was available in this revision.



- Cameras used USB 1.1 interface working at 12 Mbps transfer speed.
- Camera driver was called “g2ccd”.
- Image download time was approx. 3-times longer compared to revision 4.
- Peltier hot side was cooled by two fans.
- Desiccant container was hidden inside the camera head, it was necessary to open the head to exchange it.
- Internal filter wheel has 98 mm diameter.

## Revision 2

The second revision of G2 cameras added models G2-1600 and G2-3200 and

the original model changed name to G2-0402.



- Digital electronics was completely overhauled and upgraded to USB 2.0 interface with 480 Mbps transfer speed.
- The air intake vents shaping was slightly changed to make the camera somewhat quieter. This revision still used two fans.
- Camera driver was named “g2ccd2”, the digit “2” in the suffix signaled USB interface version.

## Revision 3

Yet another version of the digital electronics was developed for the new G3 series of CCD cameras with detectors up to  $36 \times 24$  mm (digital electronics board is the same for various models of the same series, individual models differ in analog electronics, designed for every particular type of CCD). The same electronic module was later reused also in G2 cameras and even later in the even bigger G4 series. The third revision of G2 cameras was introduced.



- The most prominent visual difference of revision three is the usage of a single and slightly larger (and again slightly more quiet) cooling fan

instead of two smaller fans employed by previous revisions.

Information on the camera head (Camera Id, Serial number etc.) was placed on the sticker at first, but later it was laser engraved directly to the aluminum shell. But this difference is only visual and does not define new revision.

- The enlarged desiccant barrel allowed much easier desiccant exchange without opening of the camera head (accessible from the outside).
- Number of models of G2 cameras were offered – KAF detector variants (G2-0402, G2-1600, G2-3200), KAI detector variants (G2-2000, G2-4000) and also “astrophotographic” model with ABG KAF detector (G2-8300).
- Internal filter wheel diameter was shrunk to 95.5 mm.
- Camera driver was named “g3ccd”. The slightly confusing naming of G2 and G4 camera drivers originated here – all three series (including the G3 one) used the same, software compatible electronics and thus also the same driver.

More exactly two drivers for two versions of these cameras were introduced, one for Full-Frame KAF CCD based cameras (g3ccdF) and the second for Interline-Transfer detectors KAI CCD based cameras (g3ccdI). Differentiation is necessary because of fundamental differences in driving of CCD chips of the above mentioned architectures.

Number of internal updates were performed on G2 cameras revision 3, for instance variants for external filter wheel were developed, additional heating of the cold CCD chamber front optical window was added, near-IR preflash capability was introduced for KAF based models etc. But cameras were the same from the outside and they were software compatible and used the same driver.

## Revision 4

Development of another version of digital electronics, using modern electronics circuits, required introduction of new revisions of G2, G3 and G4 cameras. G2 series advanced from revision 3 to 4 and G3 and G4 series are now in revision 2.



- The G2 revision 4 shell underwent a slight facelift. Camera is less “boxy” and more similar to bigger G3 and G4 models. Air intake vents are better protected against unwanted interference of rotating fans with either fingers of various wires (hitting a rotating fan with finger is not dangerous, only somewhat unpleasant).

Basic mechanical dimensions (width, height, depth) of the camera heads did not change. Only the distance of the optical axis relative to camera body center axis is slightly shifted by 2 mm.

- Desiccant container of the G2 cameras was enlarged, it is now identical to the container used on G3 and G4 models.
- CCD cold chambers of all models were significantly redesigned. New chambers bring better CCD insulation from the environment and thus require less frequent desiccant exchanges. They also allow usage of CCDs without cover glass, which are much more demanding to insulation, absence of moisture etc.
- New digital electronics uses 480 Mbps USB 2.0 interface (Gx cameras use only a small fraction the transfer capacity of this interface, so moving to 4.8 Gbps USB 3.0 brings no advantages, only problems with bigger connector, shorter and less flexible cables etc.), still it brings numerous important improvements, like faster image download (especially in the Preview mode), much bigger internal memory buffers or more precise temperature regulation.
- New drivers were unified and named “gXccdF” and “gXccdI” (for FF and IT detectors). G2 cameras employing Back-Illuminated E2V detectors use new driver “gXccdBI”.